

Varenummer: 0109034
 Beskrivelse: Seeger låsering AS 18X1.5
 Fjederstål
 Note: Monteres med ZGA tang

Mål

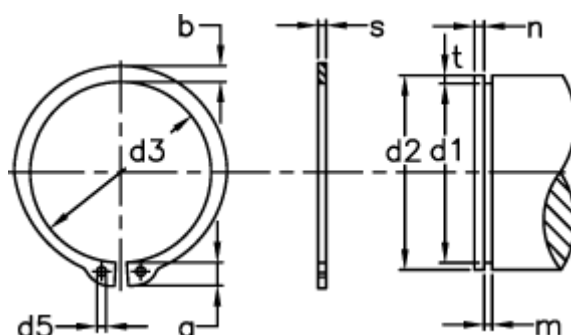

a max	= 5.1	d5 min	= 2.0	s	= 1.50
AN mm ²	= 33.0	FN kN	= 5.50	t	= 0.50
B	= 1.56	FRg kN	= 5.8	Tang	= ZGA-2
b	= 2.7	FR kN	= 26.6	tol	= -0.06
Betegnelse	= AS 18	g	= 1.5	tol	= +0,10 -0,36
d1	= 17.0	m min	= 1.60	tol	= -0.11
d2	= 18	n abl x 1000	= 43	vægt kg/1000	= 1.54
d3	= 16.5	Nominel træk	= 1.8		